



# BAVARIA® Steel In-wall Fire Cabinet

Type

## TAURUS



### Applications:

The TAURUS model emulates the steel fire cabinet using high quality steel 100% electrostatic pure polyester red coating. Bavaria steel in-wall fire cabinet is suitable for use in both areas outdoors & indoors, as in offices, schools, sports areas, cinemas, assembly rooms, hotels, resorts, malls, airports, hospitals industrial and commercial fire protection needs , such as manufacturing, petroleum companies, warehouse, apartment buildings, restaurants, malls, and else ...



**BAVARIA** EGYPT (S.A.E.)  
Gisir El Suez St. Block 109, Industrial Zone,  
Ismailia Desert Road, Cairo-Egypt  
PO Box: 2016/11111 Cairo-Egypt

Tel. : + 20 (2) 2182 0604 / 5 / 6  
Fax : + 20 (2) 2182 0609  
Website : [www.bavaria-firefighting.com](http://www.bavaria-firefighting.com)  
Email : [international.sales@bavaria.com.eg](mailto:international.sales@bavaria.com.eg)



**BAVARIA** Brandschutz Industrie GmbH & Co. KG  
Regensburger Str. 16,  
93449 Waldmunchen  
Germany

Tel. : + 49 (9972) 9401-0  
Fax : + 49 (9972) 9401-17  
Website : [www.bavaria-firefighting.com](http://www.bavaria-firefighting.com)  
Email : [info@bavaria-brandschutz.de](mailto:info@bavaria-brandschutz.de)



## BAVARIA® Steel In-wall fitting Fire Cabinet

Type: **TAURUS** High Hazard ★★★★★

### Cabinet Features:

- Standard design cabinet 800 x 800 x 300 mm (WxHxD) for in-wall fitting as a recessed type.
- The cabinet door is provided with concealed axial hinges enabling it to swing up to 180°.
- The cabinet door is provided with long built in handle and close with two latching points.
- The cabinet has two inlet holes (upper & lower) for water feeding pipes sealed with polymer or rubber seals.
- The fire cabinet carries photo luminescent signs that are crucial during emergency situations and power failure.

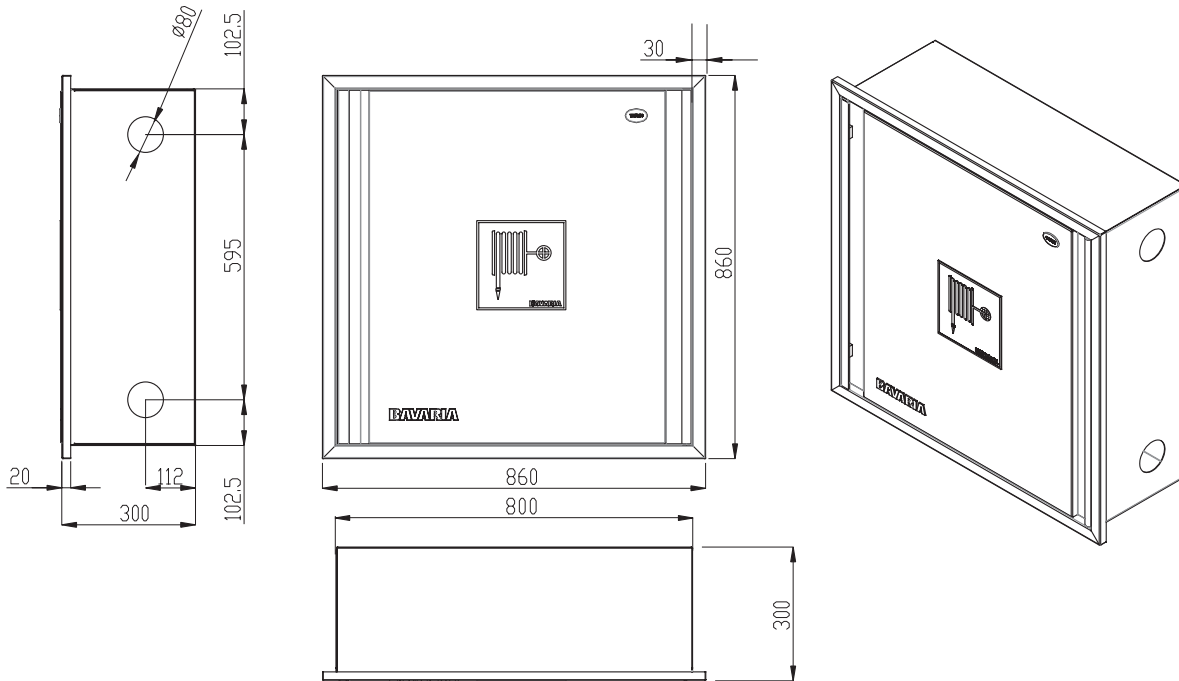
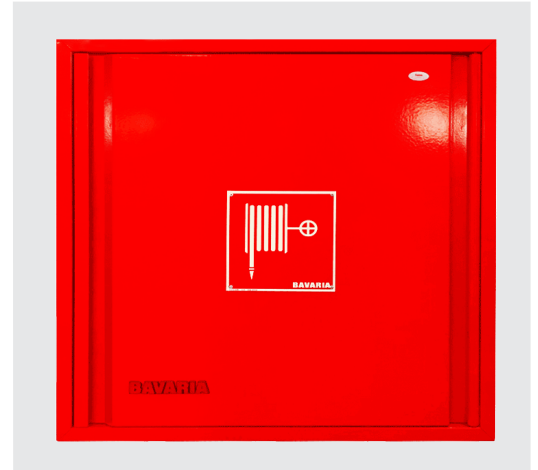

### Cabinet Technical Specifications:

<b>Cabinet type</b>	<b>TAURUS</b>
Cabinet Dimensions (wxhxd)	800 x 800 x 300 mm
Cabinet Material	Steel
Opening Door	Right (standard) or left (option)
Cabinet Steel Thickness	1.5 mm
Door Hinges	Concealed galvanized steel axial hinges
Cabinet Paint Finish	Surface treatment and 100% electrostatic pure polyester red coating

## BAVARIA® Steel In-wall fitting Fire Cabinet

Type: **TAURUS** High Hazard ★★★★★

### Technical Specifications

The figures show the movement of the hose reel with the arm allows the reel to swing completely outside of the cabinet allowing smooth hose retrieval in left and right directions without hose twisting

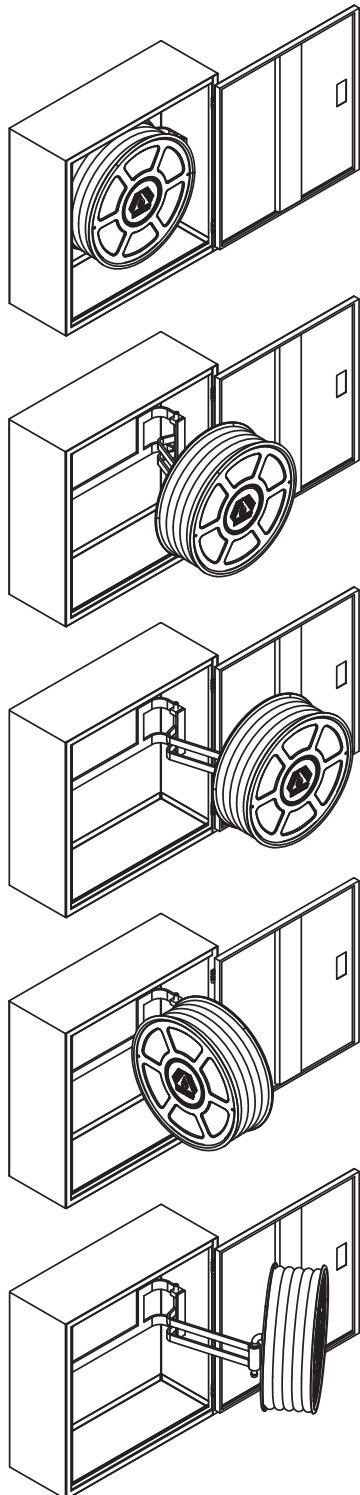

### Types of Hosereels:

- Hose reel equipped with European made ¾ inch (19 mm) diameter reinforced rubber hose, EN694 approved.
- Hose reel equipped with European made 1 inch (25 mm) diameter reinforced rubber hose, EN694 approved.
- Hose reel equipped with German made 2½ inch (64 mm) diameter flat nylon hose with internal rubber lining, DIN 50049 / EN 10204 approved.
- Hose reel equipped with German made 2½ inch (64 mm) diameter flat nylon hose with internal rubber lining, DIN 50049 / EN 10204 approved.

### Technical Specifications:

Hosereel Types	SHR- ¾	SHR-1	SHR-1½	SHR-2½
Hose Reel Diameter	650 mm / 580 mm			
Hose Reel Swinging Range	0° - 180°			
Hose Reel Material	Steel according to DIN 1623			
Hose Reel Paint Finish	Surface treatment and 100% polyester coating			
Type	SHR- ¾ / SHR-1			
Water Way	Manual Valve For Hose Reel			
Water Way Material	Nickle-Chrome Plated Brass			
Water Way Diameter	1 inch (25mm)			
Option	Automatic Valve for Hose Reel			



## BAVARIA® Steel In-wall fitting Fire Cabinet

Type: **TAURUS** High Hazard ★★★★★

**Standard Components** For Fire Cabinets with 64 mm (2 ½ inch) x 30 m / 38 mm (1½ inch) Diameter x 30 m Length

### Technical Specifications

#### DELIVERY HOSES

Type	Bavaria Standard - Type 1
Country of Origin	German made
Hose Diameter and Length	64 mm (2 ½ inch) x 30 m / 38 mm (1½ inch) x 30 m
Fabrication	Flat nylon hose with internal rubber lining
Optimum Working Pressure Range	17 bar
Hose Bursting Pressure	50 bar
Hose Coupling	Equipped with instantaneous coupling BS 366, 64 mm (2 ½ inch)
Approval	DIN 50049 / EN 10204



Landing Valves (fire valves) with 30° Outlet - For hose diameter 64 mm (2 ½ inch) / 38 mm (1½ inch)

Country of Origin	German made
Inlet thread	G 2½ A
Outlet Inst. female	2½"-Alu
Weight (kg)	2,700
Coupling Type	2.5 inch instantaneous coupling BS 336
Approval	DIN 14461-3

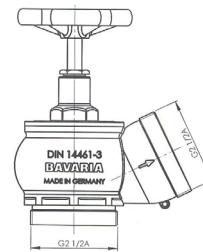

DIN 14461-3

BAVARIA water branchpipe for hose diameter 64 mm (2 ½ inch) / 38 mm (1½ inch)

Type	BAVARIA
Material	High strength aluminium alloy
Operation Mode	Full jet
Optimum Working Pressure Range	Up to 16 bar
Max. Output	215 l/min when the ball valve is completely opened
Max. Throw Range	27 m @ nozzle pressure 6 bar
Coupling Type	2.5 inch instantaneous coupling BS 336





## BAVARIA® Steel In-wall fitting Fire Cabinet

Type: **TAURUS** High Hazard ★★★★★

**Standard Components** For Fire Cabinets with 19 mm ( ¾ inch) x 30 m / 25 mm (1 inch) Diameter x 30 m Length

### Technical Specifications

DELIVERY HOSES	
Country of Origin	European made
Hose Diameter and Length	19 mm ( ¾ inch) x 30 m / 25 mm (1 inch) x 30 m
Fabrication	Reinforced Rubber hose
Max. Working Pressure Range	12 bar
Hose Bursting Pressure	Over 42 bar
Hose Connection	Bosch pressed collet
Approval	EN694



Landing Valves (fire valves) with 34° Outlet - For hose diameter 25 mm (1inch)	
Inlet thread	G 1
Outlet male	G 1 - Brass Nipple- for hose diameter 25 mm (1 inch) crimped with a ( collar) ferrule
Weight (kg)	0.450



BAVARIA Multipurpose water nozzle - For hose diameter 19 mm ( ¾ inch) / 25 mm (1 inch)	
Type	BAVARIA
Country of Origin	German made
Material	Made of Copper alloy, and has external polymer cover, as well as it has a rubber ring in the front for impact protection
Operation Mode	Multipurpose (jet and spray) nozzle
Flow Rate	up to 72 l/min at 6 bar
Max. working Pressure	16 bar
Max. Throw Range	Throw distance 21 m at 6 bar, at full jet
Hose Tail	1 inch









## BAVARIA® Steel In-wall fitting Fire Cabinet

Type: **TAURUS** High Hazard ★★★★★

### Option Accessories with Extra Cost

■ **Angle Hose Valve is used as a Fire Dept. outlet connection.**

Hose Diameter	¾ inch and 1 inch	2½ inch
Material	Brass	
Material Type	(RB) Rough Brass / (PB) Polished Brass (option)	
Inlet / Outlet	a 1½" / b 1½"	a 2½" / b 2½"
Conection type	Double Female / female x male	Double Female / female x male
Approval	UL and FM	UL and FM

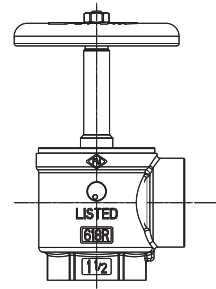

■ **Pressure reducing device angle valve**

Adjustable restriction of residual pressures up to 175 lb = 80 kg. Locking pin device restricts full opening of valve by untrained personnel, pin may be removed by firefighters to allow full opening of valve.

Hose Diameter	¾ inch and 1 inch	2½ inch
Material	Brass	
Material Type	(RB) Rough Brass / (PB) Polished Brass (option)	
Inlet / Outlet	a 1½" / b 1½"	a 2½" / b 2½"
Conection type	Double Female / female x male	Double Female / female x male
Approval	UL and FM	UL and FM

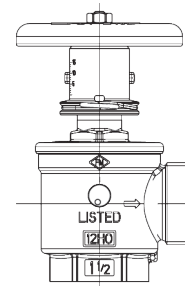

■ **2½ inch Instantaneous female adapter with male thread**

**Features:**

- Easy for quick connecting to your fire equipment

**Instantaneous Dust Plug with Chain In Plastic (21/2") BS 336**

To cover and protect male outlet connections on valves hydrants. Prevents entry of foreign material.



Standard Materials	Body: Rough Brass alloy 2½ inch instantaneous adapter and polymer dust plug with chain attachment: slated steel
--------------------	---

**Warranty:**

Period of Warranty	2 Years
Coverage of the Warranty	Against material failure and production defects
Method of Warranty Coverage	Limited to the replacement of the defected part or product after verification that the failure is covered by the scope of the warranty
Warranty Exclusions	Failures due to misuse, mishandling, or inspection or repair by an unauthorized dealer or entity

\* The illustrations may show optional extras only available at extra charge. BAVARIA retains the right to alter specifications and illustrations given herein without prior notice. Specifications will only be considered communicated at placing of order.